

CS 4/56101

Design & Analysis of Algorithms

- **Course Website:**
 - <http://www.cs.kent.edu/~hmichaud/daa-f19/>
- **Instructor:** Heather M. Guarnera
 - Office: MSB 352
 - Office Hours: by appointment
 - Email: hmichaud@kent.edu (**Piazza** is best)

Books

- Textbook:

Algorithm Design: Foundations, Analysis, and Internet Examples, by Michael T. Goodrich and Roberto Tamassia, 1st edition, Wiley, 2001

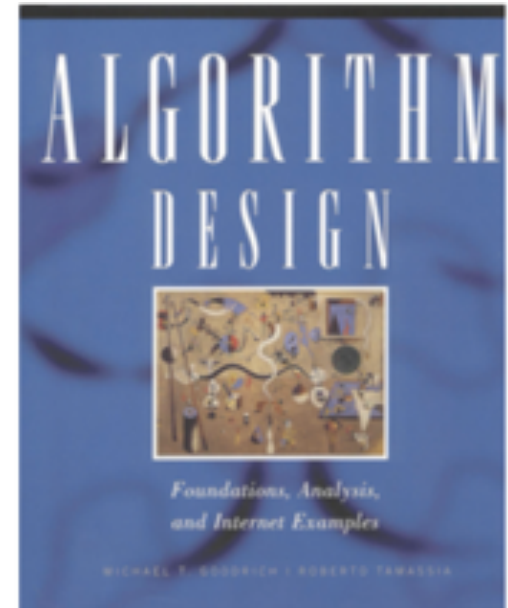

- An excellent reference:

Introduction to Algorithms, 3rd Edition, by T.H. Cormen, C.E. Leiserson, R.L. Rivest, and C. Stein, MIT, 2009.

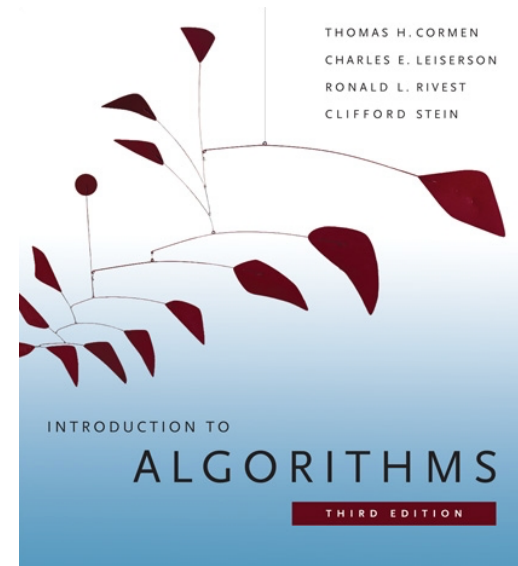

Course Requirements

- Homework **35%**
 - Good preparation for exams
 - Homework is weighted based on different problems
- Exams (closed book, no calculators, one sheet of notes)
 - Midterm **30%** tentatively, mid October
 - Final **30%** Friday, December 13 @ 7:45-10:00am
- Participation **5%**
 - Engagement **in class** and on **Piazza**

Other Syllabus Info

- Late Policy
 - Homework must be turned in by the end of class on the due-date.
 - Unexcused late homework is not accepted.
 - Missed exams and missed homework are only excused if absence was essential and can be fully documented.
- Registration Requirements
 - **Aug. 28:** Official registration deadline
 - **Sept. 4:** Last day to withdraw before a grade of “W” is assigned
 - **Oct. 30:** Last day to withdraw with a grade of “W” assigned
- Student Survey of Instruction
 - Available online during the last two weeks of class

Example: Boss assigns a task

- Given today's prices of pork, grain, sawdust, etc...
- Given constraints on what constitutes a hotdog.
- Make the cheapest hotdog.

Every industry asks these questions.

- Mundane programmer: “Um? Tell me what to code.”
- Better: “I learned an algorithm that will work.”
- Best: “I can develop an algorithm for you.”

How to do this?

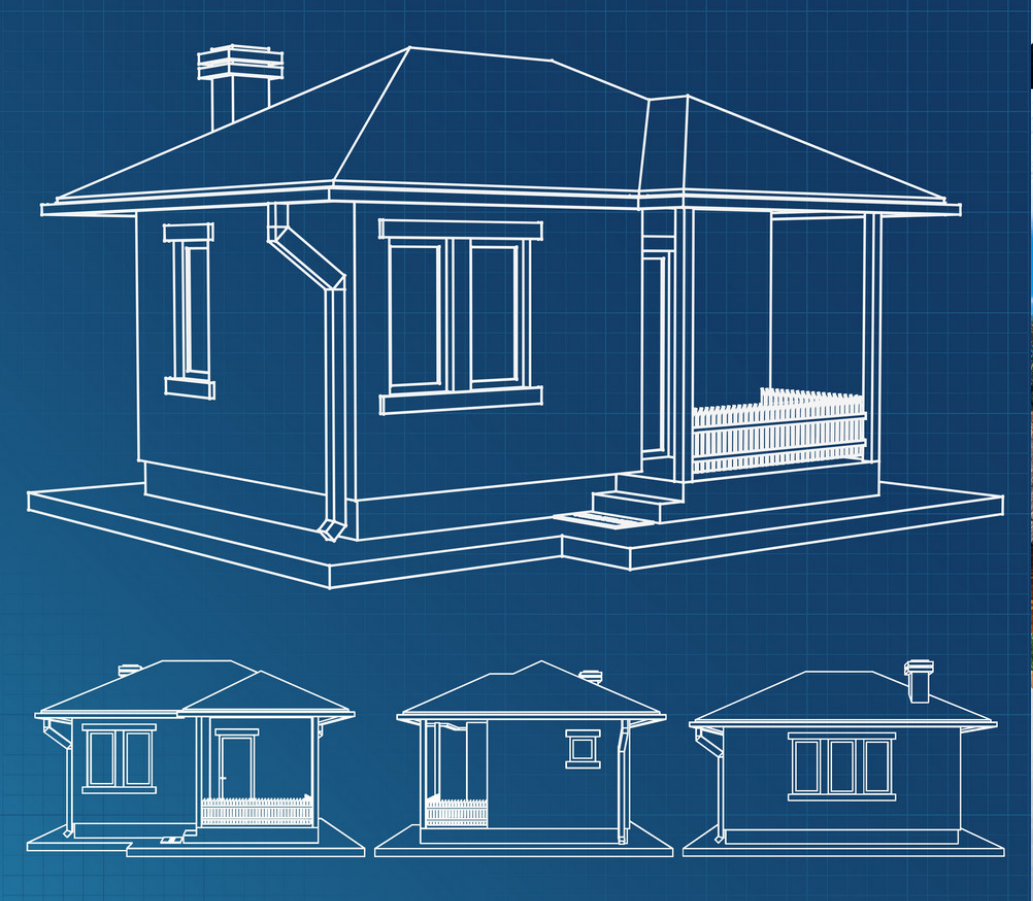
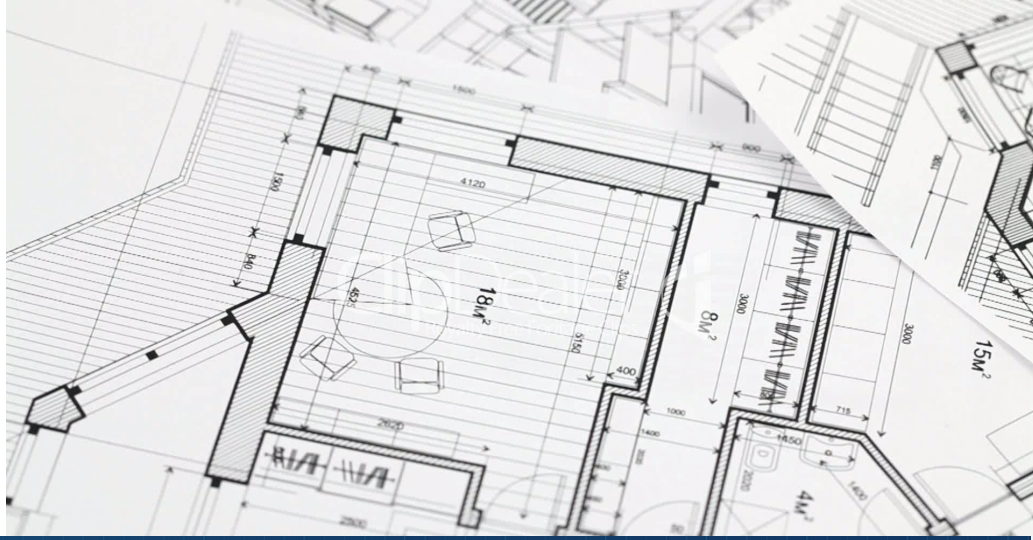

Tools you need

Example: Design an inventory system which can quickly find an item.

- What data structure to use?

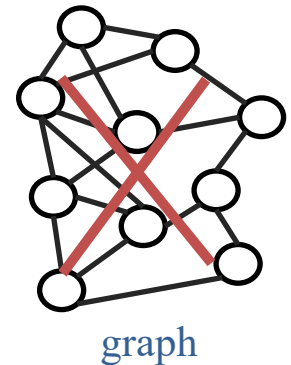
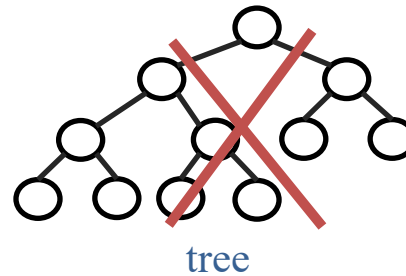
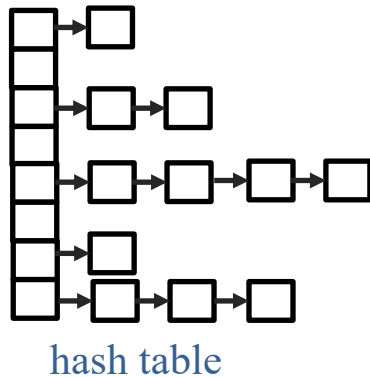
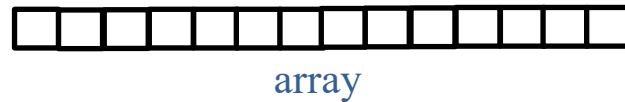
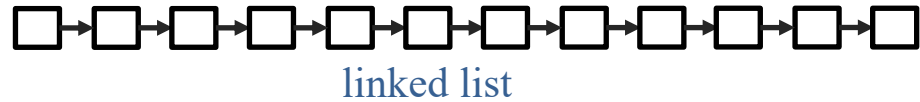
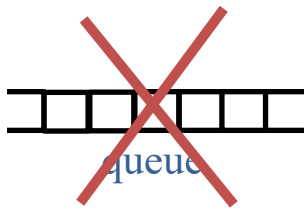
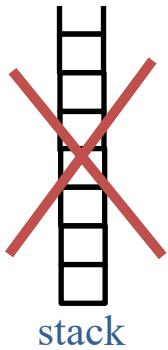

Tools you need

Example: Design an inventory system which can quickly find an item.

- What approach to take?

Brute force

Dynamic programming

Divide and conquer

Greedy method

Prune and search

- Are there any existing algorithms that could be used/modified?

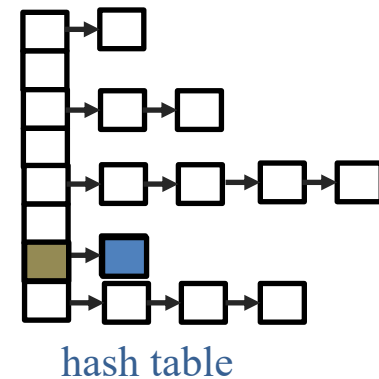
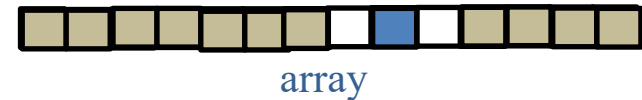
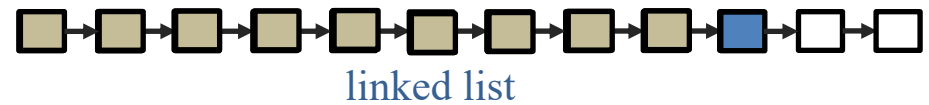

Tools you need

Example: Design an inventory system which can quickly find an item.

- How to determine which solution is best?
- Does it **work** as required?

Rationalization

Proof of correctness

- How much memory is required? How long does it take?

Big-oh notation

Amortization

Complexity analysis

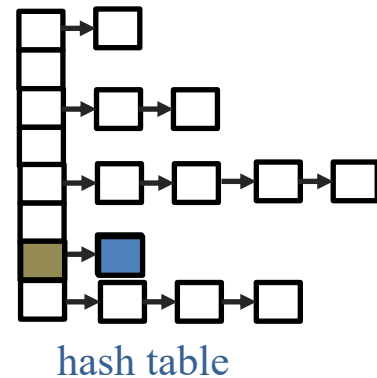
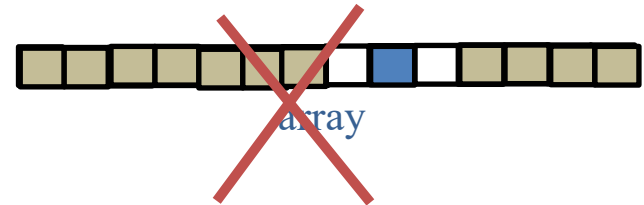
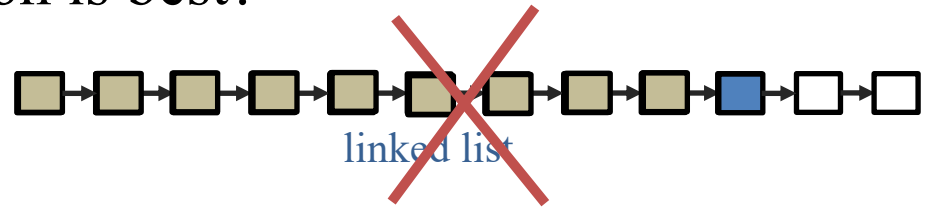

Design & Analysis of Algorithms

- How to **evaluate algorithms** (correctness, complexity)
 - Notations and abstractions for describing algorithms
- Advanced **data structures** and their analysis
- Fundamental **techniques** to solve the vast array of unfamiliar problems that arise in a rapidly changing field
 - Up to date grasp of fundamental problems and solutions
 - Approaches to solve
- To **think algorithmically** like a ‘real’ computer scientist

Course Content

- A list of algorithms
 - Learn the code
 - Trace them until you are convinced that they work
 - Implement them.

```
class InsertionSortAlgorithm extends SortAlgorithm
{
    void sort(int a[]) throws Exception {
        for (int i = 1; i < a.length; i++) {
            int j = i;
            int B = a[i];
            while ((j > 0) && (a[j-1] > B)) {
                a[j] = a[j-1];
                j--; }
            a[j] = B;
        }
    }
}
```

Course Content

- A survey of algorithmic design techniques
- Abstract thinking
- How to develop new algorithms for any problem that may arise

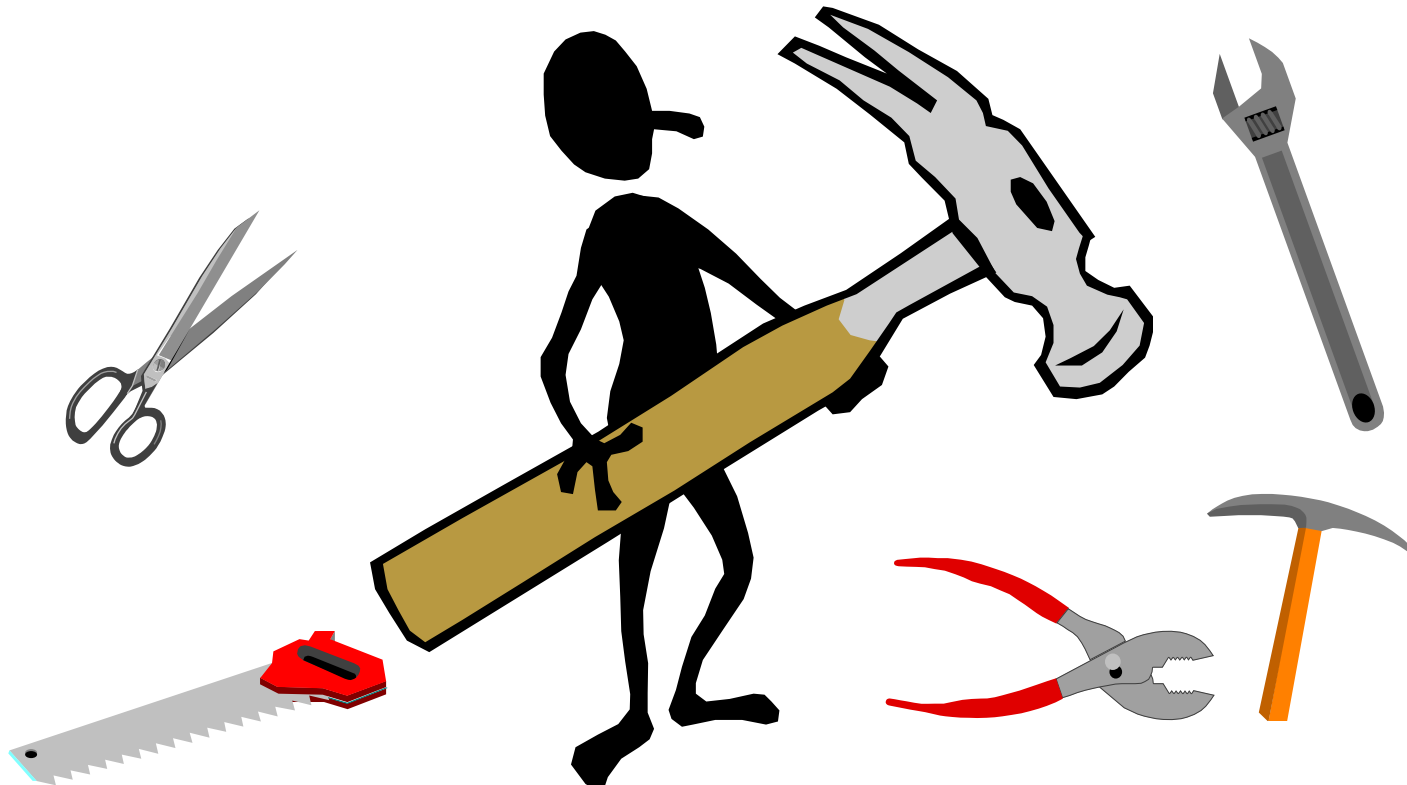

Start with some math

Time complexity
as a function

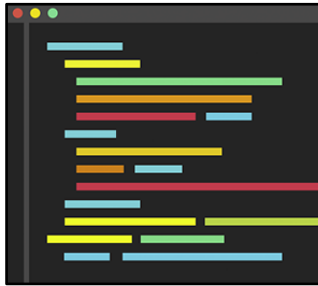

$$t(n) = \Theta(n^2)$$

Counting primitive operations

- Sequences and summations
- Linear functions
- Logarithmic and exponential functions

$$a + ar + ar^2 + ar^3 + \dots + ar^{n-1} = \sum_{k=0}^{n-1} ar^k = a \left(\frac{1 - r^n}{1 - r} \right)$$

Recurrence Relations

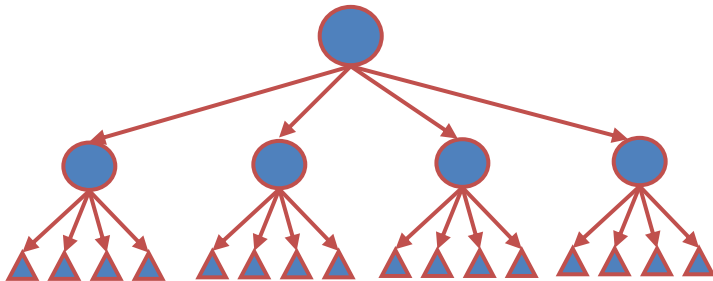

$$T(n) = a T(n/b) + f(n)$$

Classifying functions

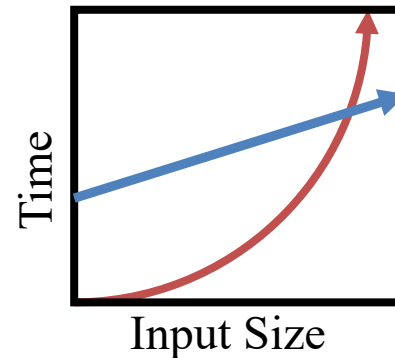

Data Structures

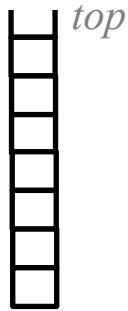

stack

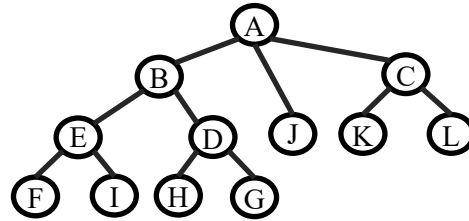

tree

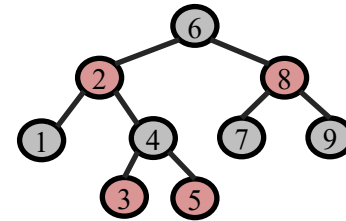

red black tree

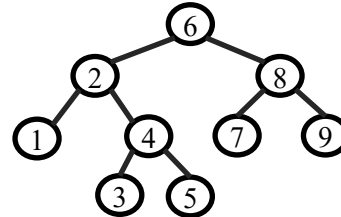

binary search tree

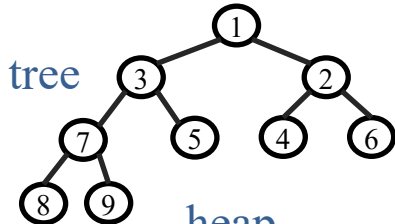

heap
&
priority queues

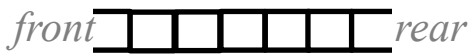

queue



linked list

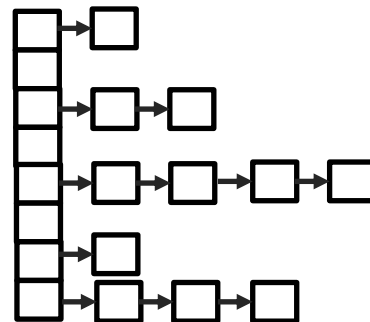

hash table
&
dictionaries



vector

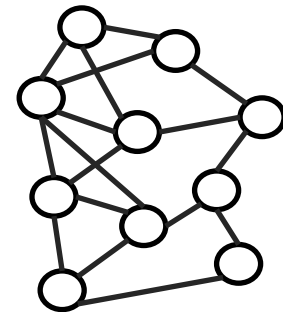

graph

Searching & Sorting

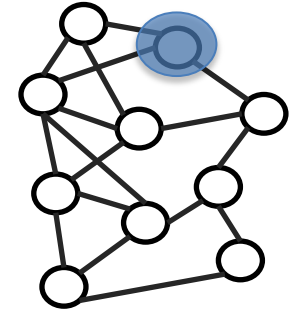
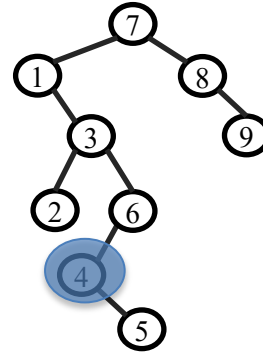
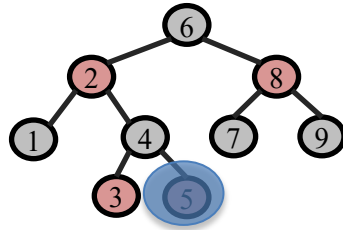
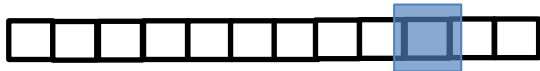

insertion sort



selection sort



heap sort



merge sort



quick sort



Fundamental Techniques

Greedy Algorithms



Divide and Conquer

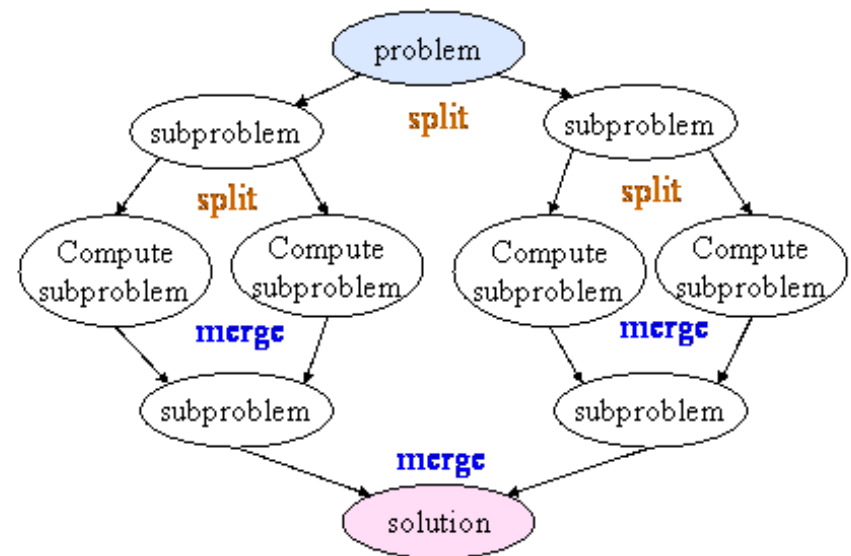

Dynamic Programming

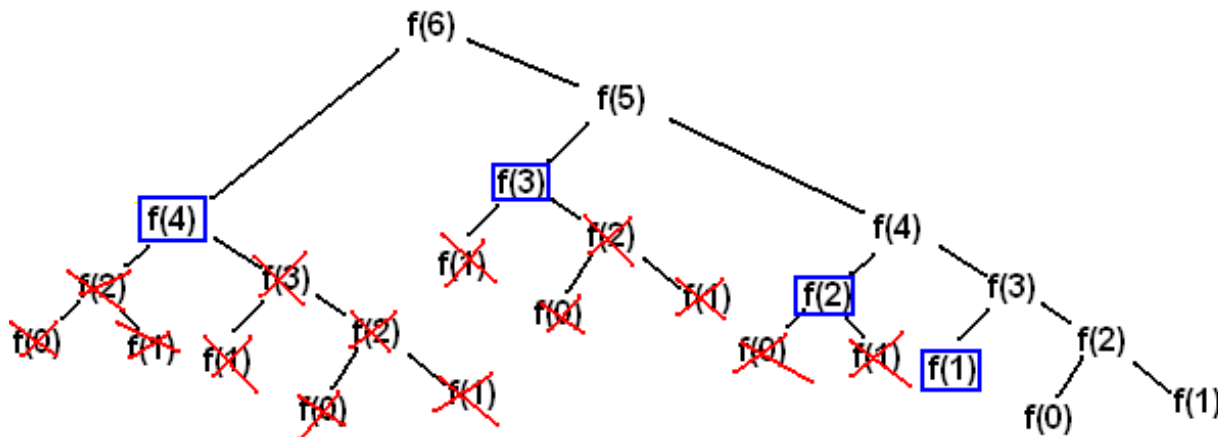

Graphs & Graph Algorithms

Graph search

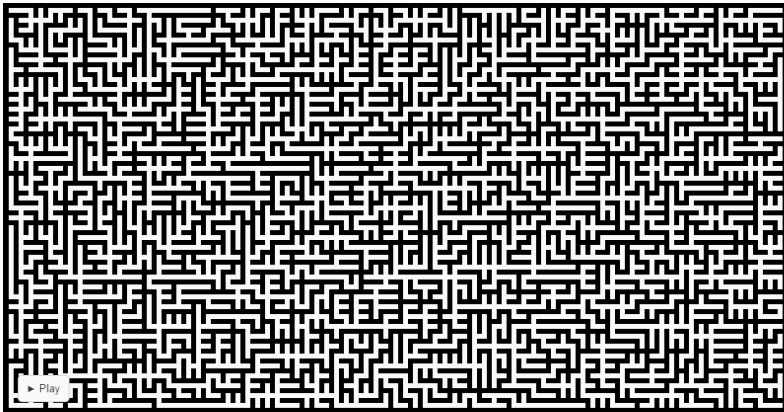

Shortest path

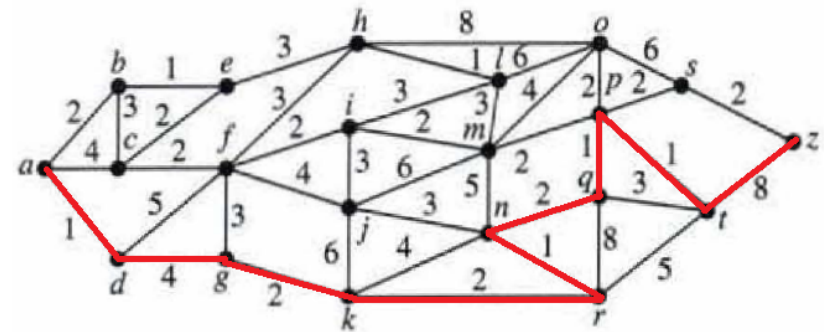

Network flow

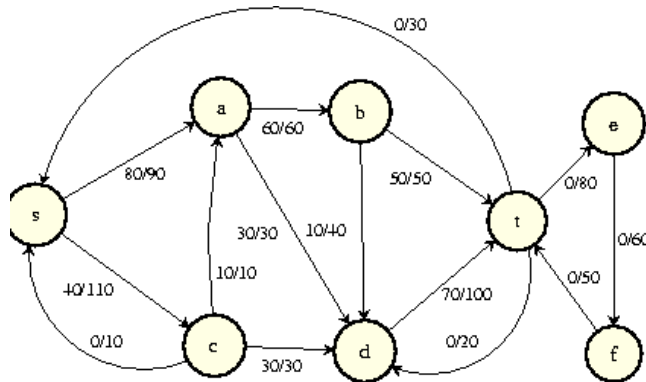

Minimum Spanning Tree

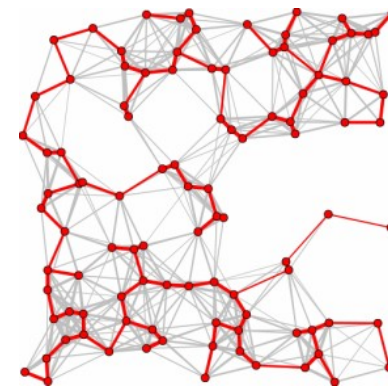

Useful Learning Techniques

- You are expected to **read ahead** (before the lecture)
 - This will facilitate more productive discussion during class
- Guess at potential algorithms for solving a problem
 - Look for input instances where your algorithm is wrong
- Practice explaining
 - You'll be tested on your ability to explain material
- Ask questions
 - Why is it done this way and not that way?